



PROJECT
PROPOSAL

معلومات عنا :

شركة بم لايت تأسست من سنة 2004 بمجال المواد الاضاءة الكهربائية و اضاءة الليد

بفضل الجودة والتصميم الفريدين لمنتجاتها وضمان لمدة 1 إلى 3 سنوات ، اكتسبت سمعة قوية وموثوقة مع عملائها.

نظرًا لوجود مصنع خاص بها في الصين وزيادة ثقة العملاء من خلال فريق استشاري ، فقد تمكن التصميم والجودة الجيدة من الحفاظ على منتجاتها على مستوى عالي للغاية وتلبية متطلبات العملاء والأسواق والمشاريع والموثوقية.

بعد من الخبرة في مجالنا في محاولة لتحسين مستوى موظفي الشركة ، قدمت دورات تدريبية على الخدمة وأساليب التعامل

لتحسين جودة منتجاتها تأخذ آراء العملاء بعين الاعتبار لتظل دائمًا في الصدارة.

تقدم شركة بم لايت جميع منتجات الإضاءة والكهرباء مثل: (سبوت لايت ، لوحات مفاتيح ، لينر ، ماكنيت ، بلاجكتورات ،

أعمدة حديقة ، براكيت ، مصابيح ديكور ، أبواب ، ثريات ، كريستال)

أصبحت ماركة بم لايت مصدرًا موثوقًا للمشاريع الكبرى في كردستان والعراق.

ABOUT US:

BAM Light Company was established in 2004 in the field of electrical lighting materials and LED lighting

With the unique quality and design of its products and a 1 to 3 year warranty, it has gained a strong and reliable reputation with its customers.

Having its own factory in China and increasing customer confidence with a consulting team, good design and quality have enabled its products to be kept at a very high level and meet customers', markets' and projects' requirements and reliability.

After of experience in our field in an attempt to improve the level of the company's employees, I provided training courses on service and customer dealing methods for employees,

To improve the quality of its products, it takes customer opinions into consideration to always remain at the forefront.

BAM Light Company offers all lighting and electrical products such as: (spotlights, switchboards, liner, magnets, luminaires, garden poles, brackets, decorative lamps, doors, chandeliers, crystal)

The BAM Light brand has become a reliable source for major projects in Kurdistan and Iraq.

عروضنا وخدماتنا للمشاريع

Our offers and services for projects

Special discount for projects
خصم خاص للمشاريع



Maintenance of our products for one year
صيانة منتجاتنا لمدة سنة واحدة

A warranty from 1 to 2 years and facilities after the end of the warranty
ضمان من سنة إلى 3 سنوات وتسهيلات بعد انتهاء الضمان

Facilitating project owners in choosing the appropriate model and type
تسهيل لأصحاب المشاريع في اختيار النموذج والنوع المناسب

PHILIPS - BRIDGELUX - OSRAM

نستخدم علامات تجارية عالمية في منتجاتنا

We use international Chops brandin our products



تعتبر به م لایت جزءاً هاماً بأضاءة هذه المشاريع

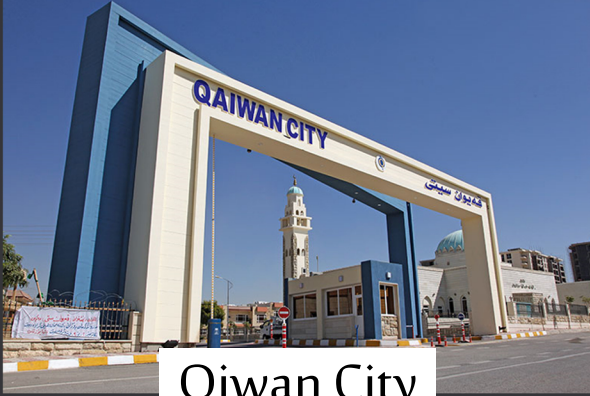

Qiwan City



Danya City

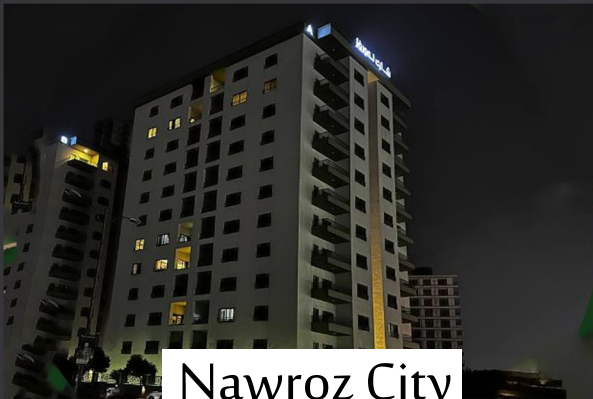

Nawroz City



Pasha City



New Chwarchra



Drimland



Ban City - Kalar



Sulaymaniyah Mani Terminal



LED and COB Downlight

Code : DS-B019

Power : 5 Watt .

CCT : 4000K – 6500K.

CRI > 95.

Hole cut size : 7 cm.

Beam Angle : 160°.

Power Factor : 0.6 .

Luminous flux : 110 Lm/W.

3 Years Warranty.

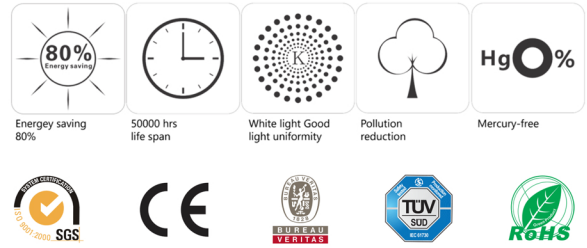

LED Downlight

Code : DS-B022

Power : 5 Watt .

CCT : 4000K – 6500K.

CRI > 95.

Hole cut size : 7 cm.

Beam Angle : 160°.

Power Factor : 0.6 .

Luminous flux : 110 Lm/W.

3 Years Warranty.

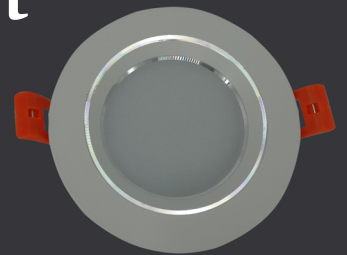



LED Downlight

Code : DS-B029

Power : 10 Watt .

CCT : 4000K – 6500K.

CRI > 95.

Hole cut size : 7 cm.

Beam Angle : 120°.

Power Factor : 0.6 .

Luminous flux : 110 Lm/W.

3 Years Warranty.

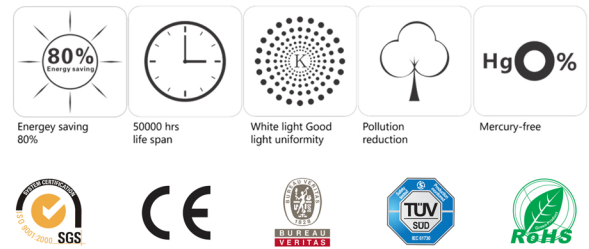

LED Downlight

Code : DS-B024

Power : 7 Watt .

CCT : 4000K – 6500K.

CRI > 95.

Hole cut size : 6.6 cm.

Beam Angle : 90°.

Power Factor : 0.6 .

Luminous flux : 110 Lm/W.

3 Years Warranty.

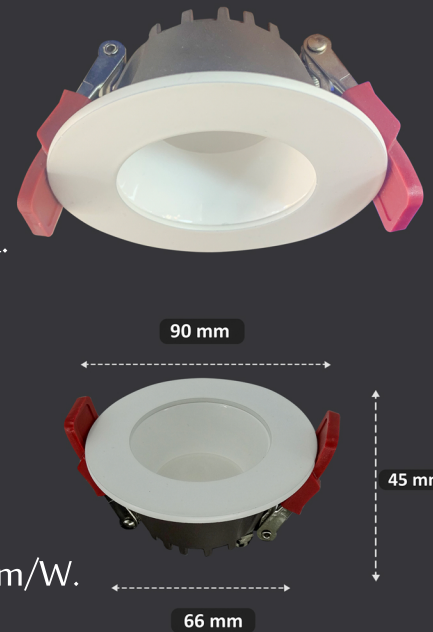

LED and COB Downlight



Code : DS-B030

Power : 7 Watt .

CCT : 4000K – 6500K.

CRI > 95.

Hole cut size : 7 cm.

Beam Angle : 90°.

Power Factor : 0.6 .

Luminous flux : 120 Lm/W.

3 Years Warranty.

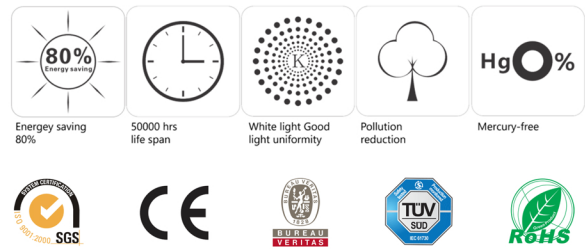

COB Downlight

Code : DS-B031

Power : 10 Watt .

CCT : 4000K – 6500K.

CRI > 95.

Hole cut size : 6.6 cm.

Beam Angle : 90°.

Power Factor : 0.6 .

Luminous flux : 120 Lm/W.

3 Years Warranty.





LED Downlight

Code : DS-156

Power : 7 Watt .

CCT : 3000K - 4000K – 6500K.

CRI > 90.

Hole cut size : 7 cm.

Beam Angle : 180^o.

Power Factor : 0.6 .

Luminous flux : 120 Lm/W.

3 Years Warranty.

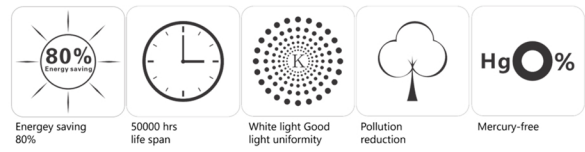

LED Downlight

Code : MW-1108

Power : 6 - 10 - 20 Watt .

CCT : 6000K – 9500K.

CRI > 85.

Beam Angle : 160^o.

Power Factor : 0.6 .

Luminous flux : 100 Lm/W.



6 95mm
Watt Ø60mm

145mm **10**
Watt Ø100mm

20 220mm
Watt Ø175mm

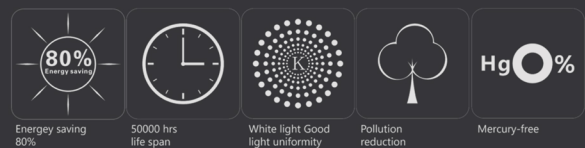

LED Downlight



Code : DS-B028

Power : 7 Watt .

CCT : 4000K – 6500K.

CRI > 90.

Hole cut size : 7 cm.

Beam Angle : 90°.

Power Factor : 0.6 .

Luminous flux : 120 Lm/W.

2 Years Warranty.

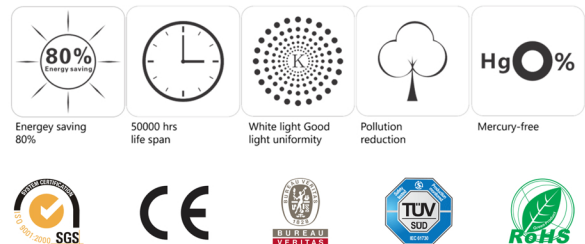

COB Downlight

Code : DS-B819

Power : 10 - 16 - 25 Watt .

CCT : 4000K – 6500K.

CRI > 95.

Beam Angle : 100°.

Power Factor : 0.6 .

Luminous flux : 130 Lm/W.

2 Years Warranty.



10 Watt 16 Watt 25 Watt



10 Watt	Size : 9 cm Hole : 7 cm
16 Watt	Size : 11 cm Hole : 8.9 cm
25 Watt	Size : 14 cm Hole : 12 cm



LED Downlight

Code : DS-B068

Power : 10 Watt .

Protection rating : IP68

CCT : 6500K.

CRI > 90.

Hole cut size : 10 cm.

Beam Angle : 160°.

Power Factor : 0.6 .

Luminous flux : 120 Lm/W.

3 Years Warranty.

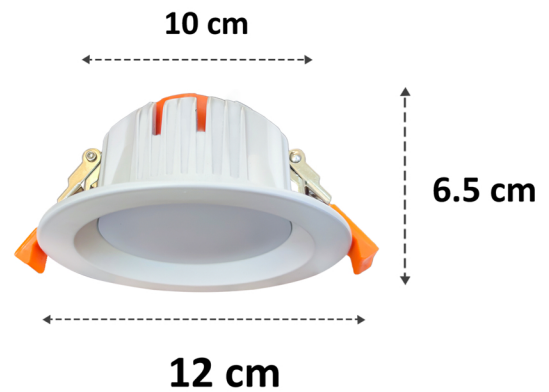
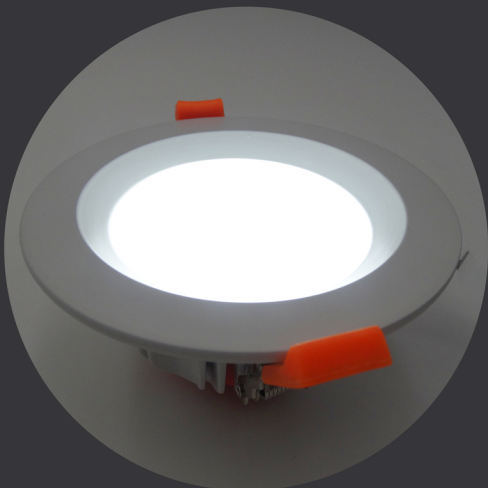
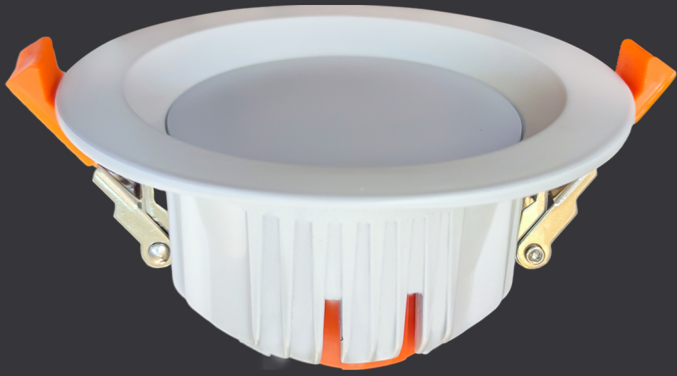

Energy saving 80%	50000 hrs life span	White light Good light uniformity	Pollution reduction	Mercury-free

--	--	--	--	--

COB Downlight

Code : DS-D302

Power : 7 -14 -21 Watt .

CCT : 4000K – 6500K.

CRI > 95.

Beam Angle : 90°.

Power Factor : 0.6 .

Luminous flux : 120 Lm/W.

3 Years Warranty.

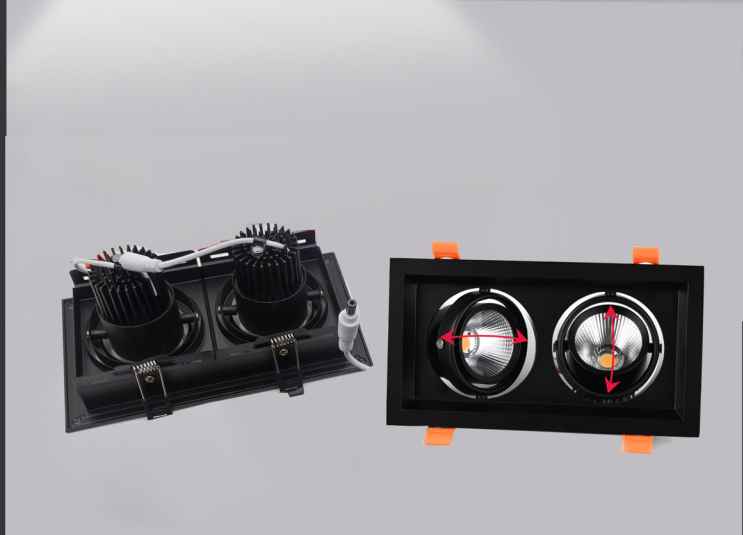

**7
Watt**



Size:
130 x 130 mm²

Cut Size:
110 x 100 mm²

**14
Watt**



Size:
130 x 225 mm²

Cut Size:
110 x 195 mm²

**21
Watt**

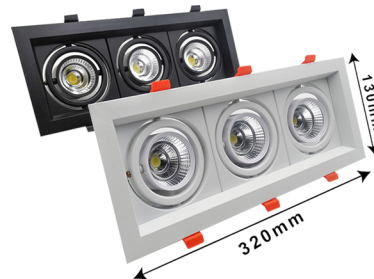

Size:
130 x 320 mm²

Cut Size:
110 x 290 mm²

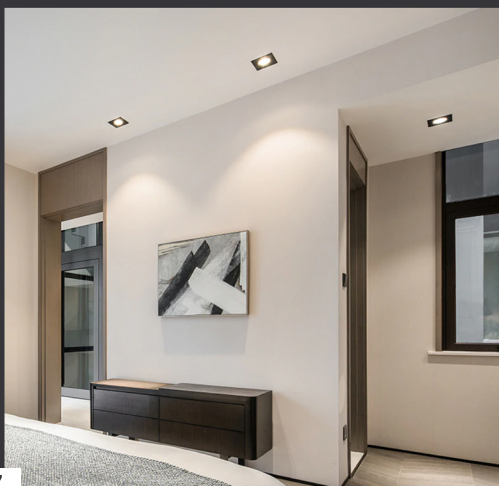

LINEAR LIGHTING PROFILES

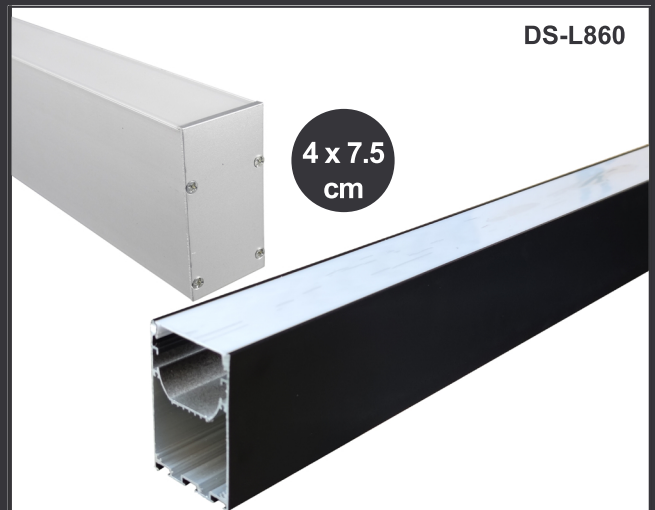
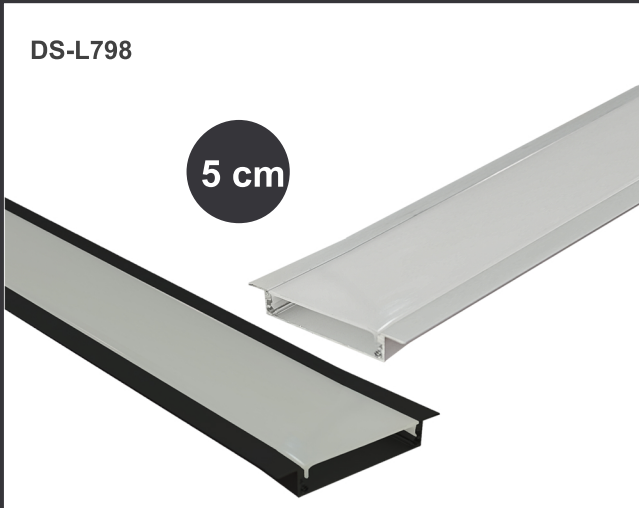



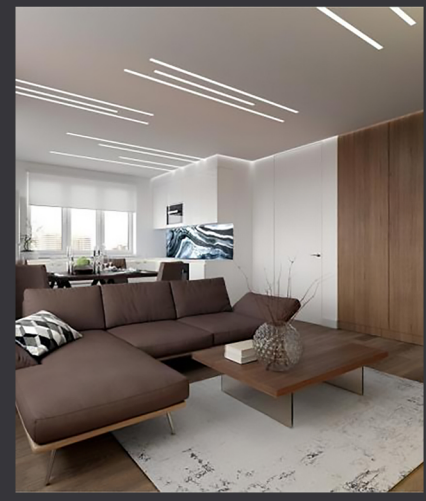
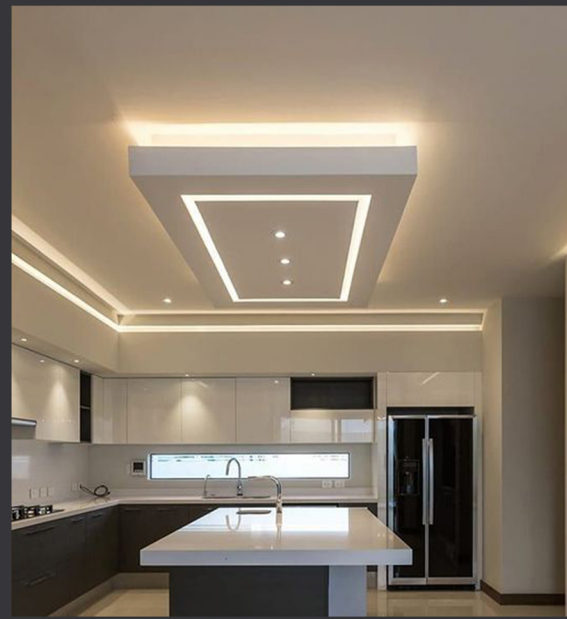
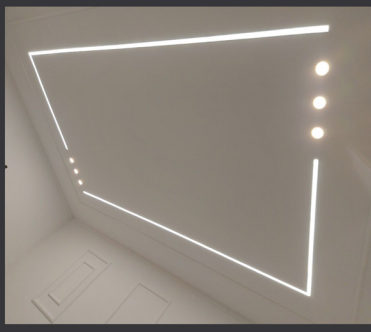

LED Magnet light

4 installation methods

recessed (Internal) mounted

recessed (External) mounted

Surface mounted

Hanging mounted

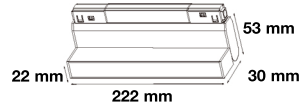

Power: 12 Watt
Lumen : 90 LM/W
CCT : 4000K - 6000K
Beam angle : 120° - 25°
CRI : CRI ≥ 90
IP rate : IP20
Material : 6063 aluminum
Voltage : DC48V



Power: 10 Watt
Lumen : 90 LM/W
CCT : 4000K
Beam angle : 24°
CRI : CRI ≥ 90
IP rate : IP20
Material : 6063 aluminum
Voltage : DC48V

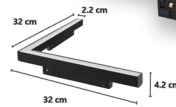
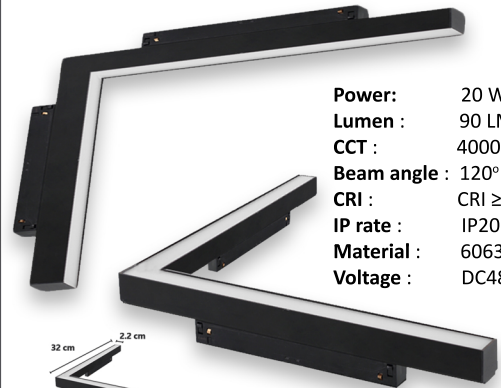

Power: 20 Watt
Lumen : 90 LM/W
CCT : 4000K
Beam angle : 120°
CRI : CRI ≥ 90
IP rate : IP20
Material : 6063 aluminum
Voltage : DC48V

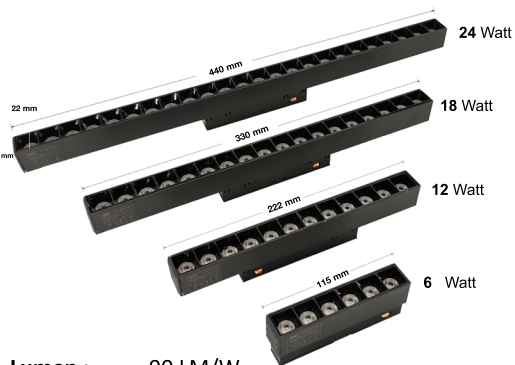

Lumen : 90 LM/W
CCT : 4000K - 6000K
Beam angle : 24°
CRI : CRI ≥ 90
IP rate : IP20
Material : 6063 aluminum
Voltage : DC48V

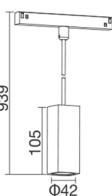

Lumen : 90 LM/W
CCT : 4000K - 6000K
Beam angle : 24°
CRI : CRI ≥ 90
IP rate : IP20
Material : 6063 aluminum
Voltage : DC48V

Lumen : 90 LM/W
CCT : 4000K - 6000K
Beam angle : 120°
CRI : CRI ≥ 90
IP rate : IP20
Material : 6063 aluminum
Voltage : DC48V

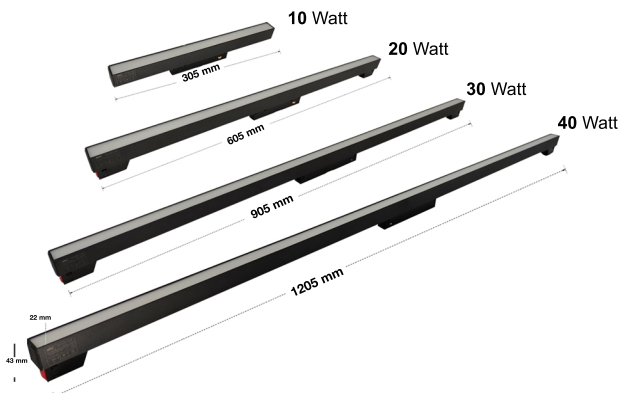



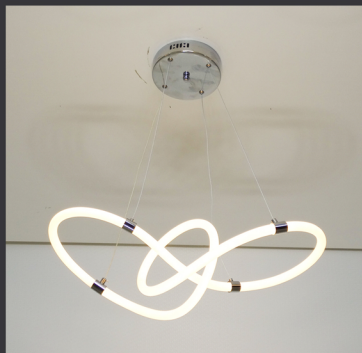



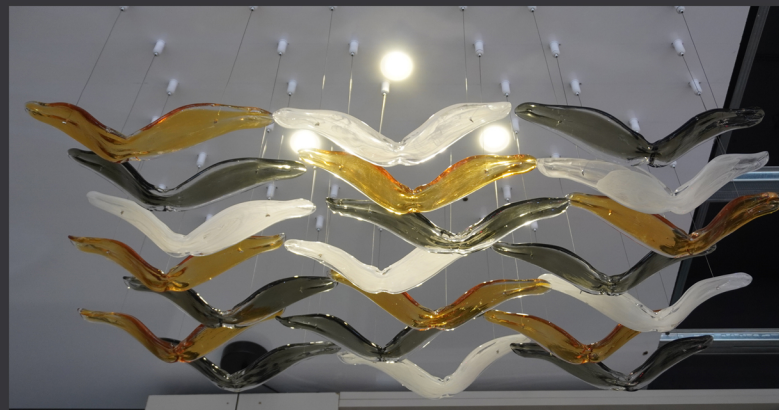

Socket and Switch



GLORY SERIES (A)



Socket and Switch



ROYAL SERIES

(B)



Socket and Switch



DIAMOND SERIES (C)



SWITCH STRUCTURE DIAGRAM

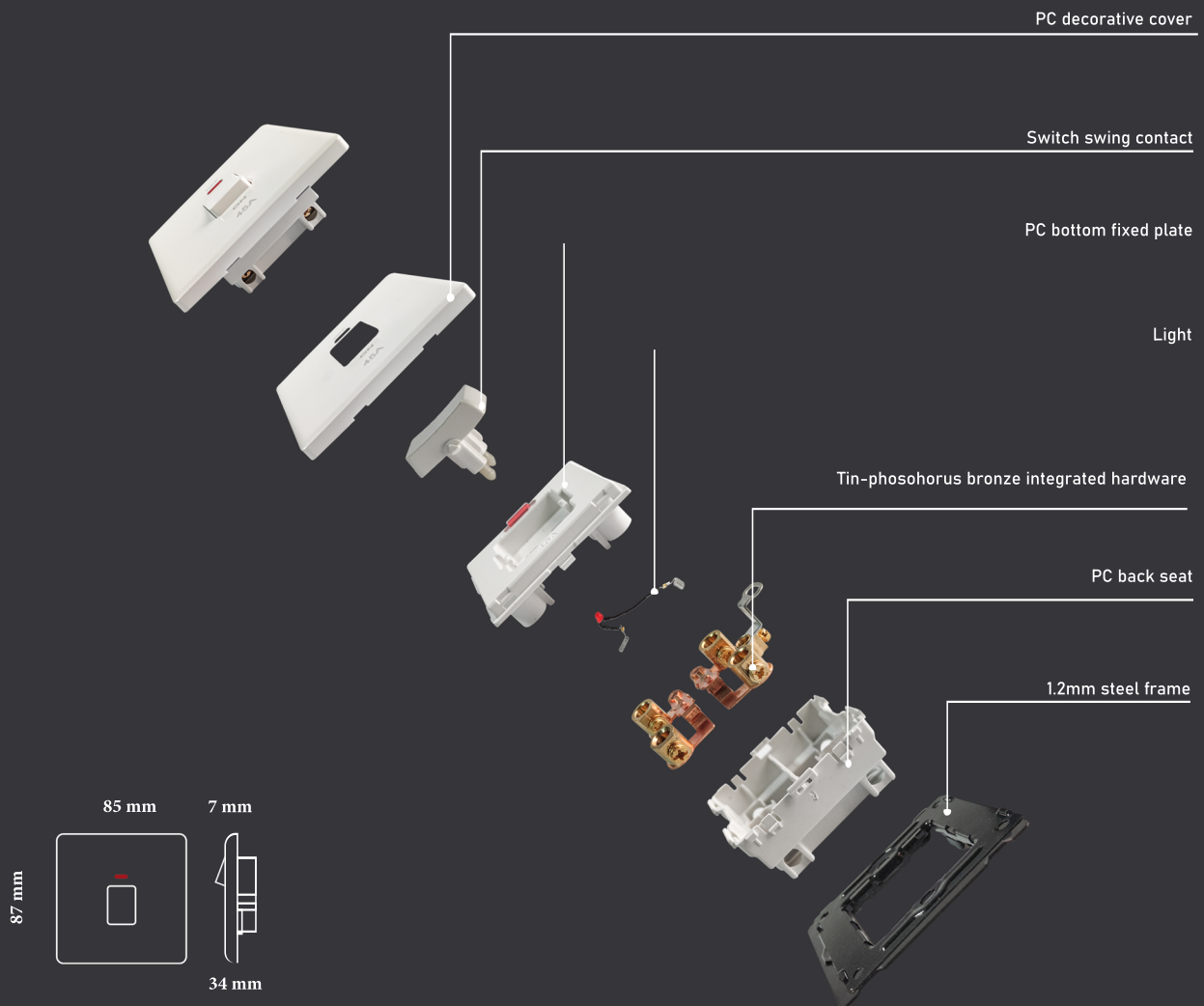
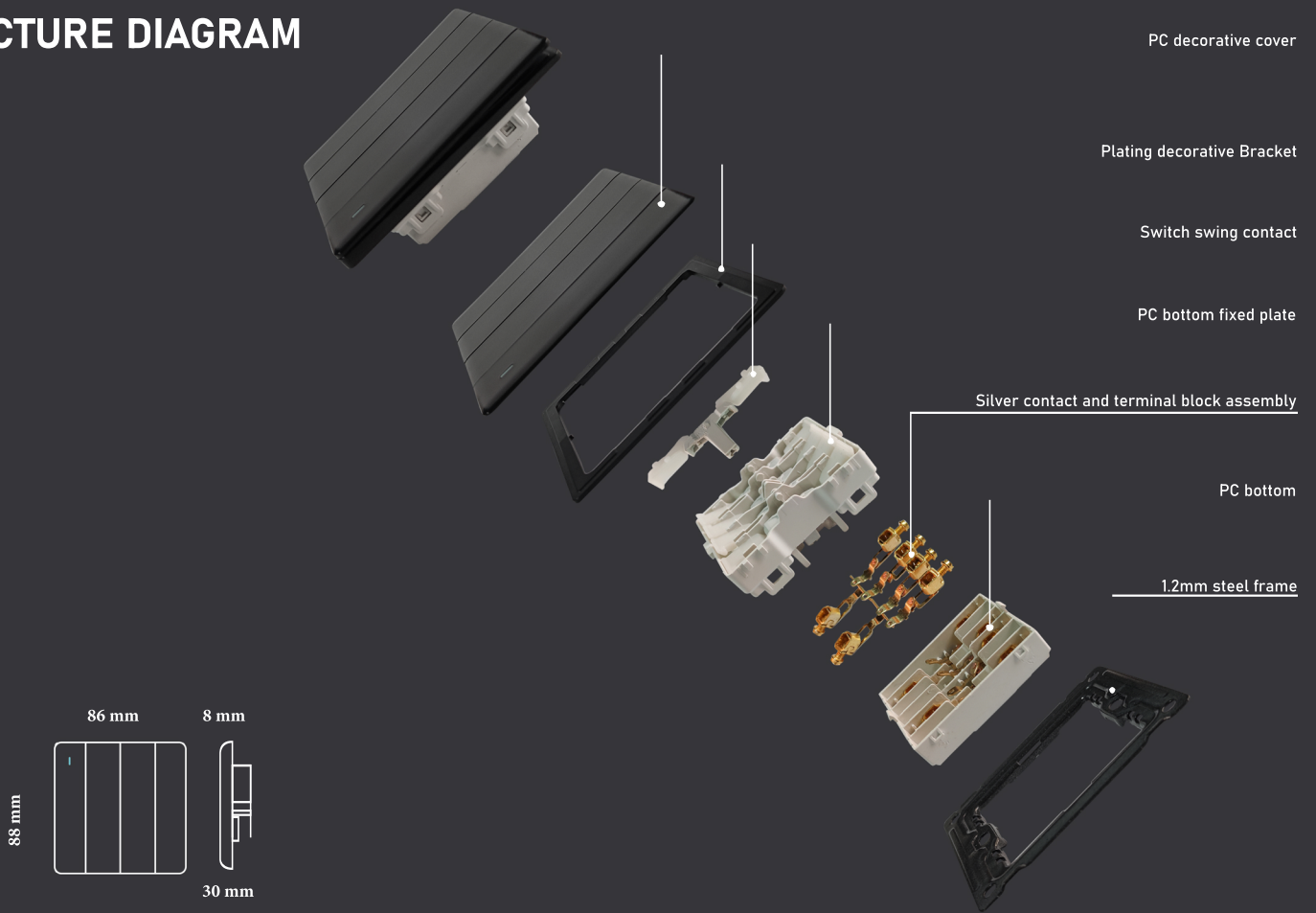

SWITCH STRUCTURE DIAGRAM

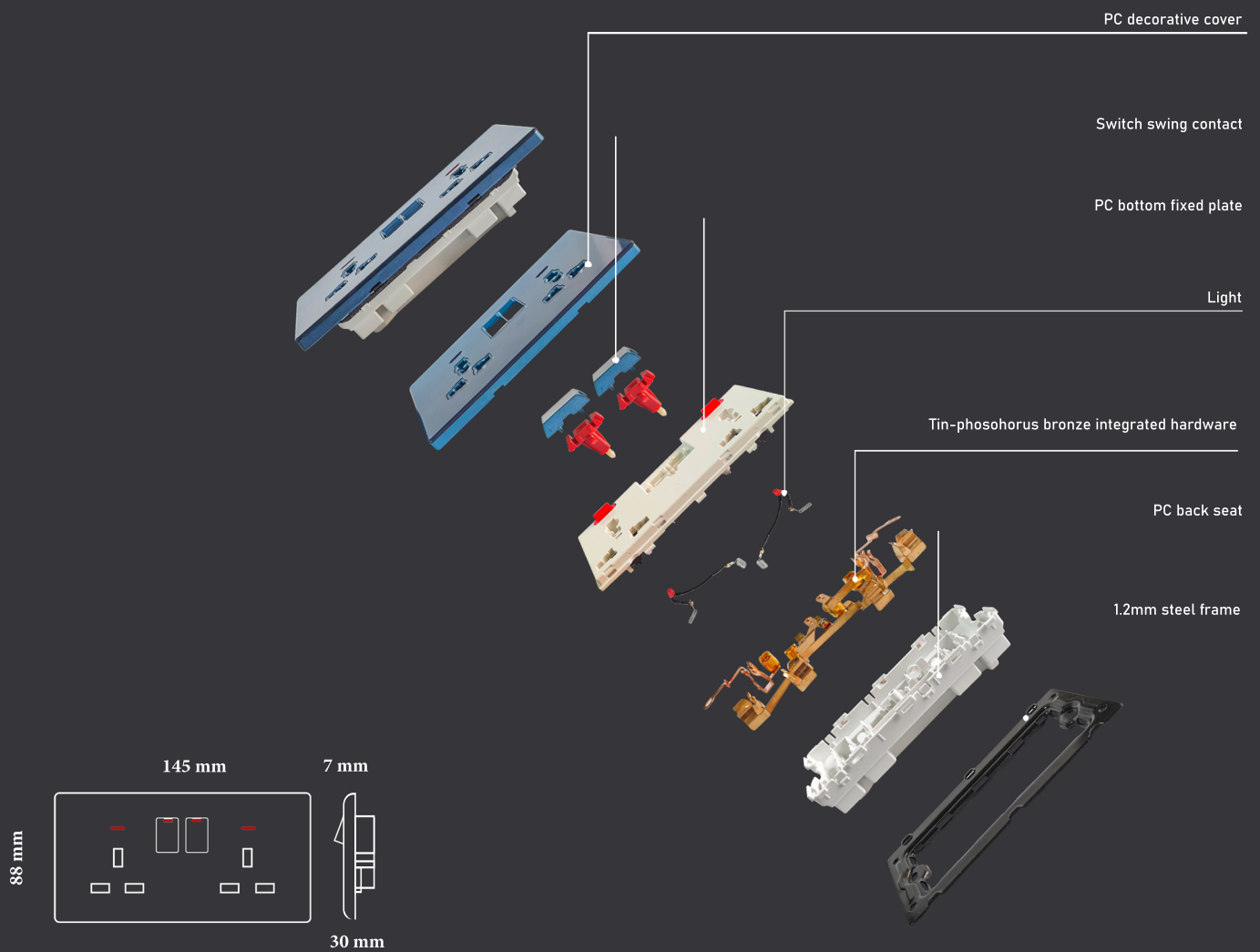
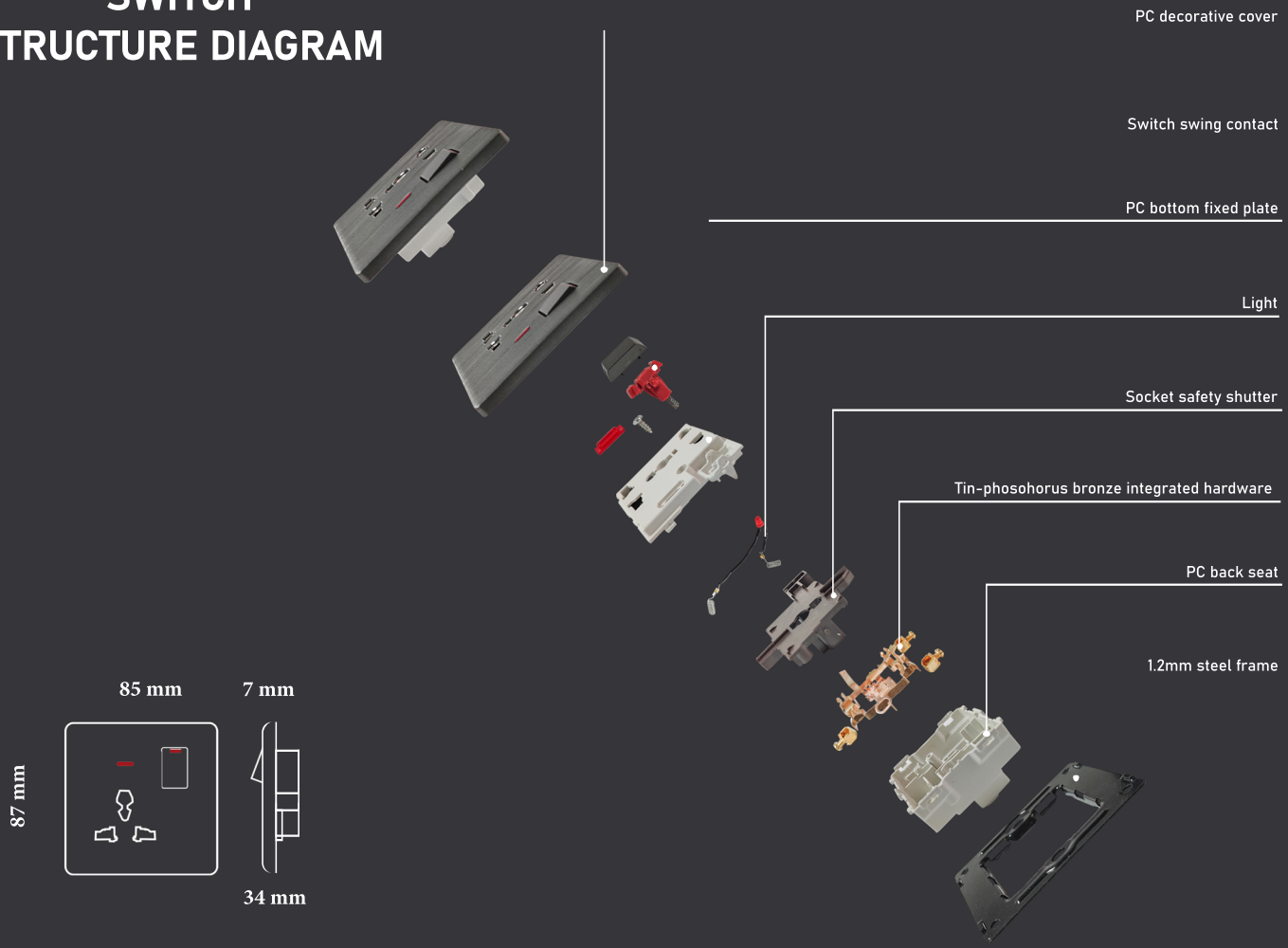

Surface Mounted Downlight



Code : DS-671 - 673

Power : 15 Watt .

CCT : 4000K – 6500K.

CRI > 90.

Size : 15x9.5 cm.

Beam Angle : 120°.

Power Factor : 0.6 .

Luminous flux : 100 Lm/W.



Surface Mounted Downlight



Code : DS-672

Power : 18 Watt .

CCT : 4000K – 6500K.

CRI > 90.

Size : 15x9 cm.

Beam Angle : 180°.

Power Factor : 0.6 .

Luminous flux : 110 Lm/W.

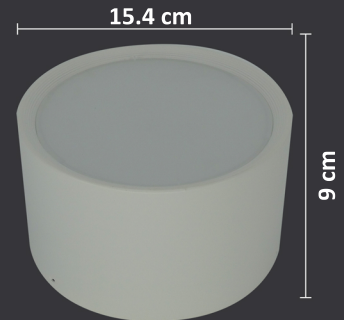

Code : MW-1104

CCT : 6000K – 9500K.

CRI > 85.

Beam Angle : 180°.

Power Factor : 0.6 .

Lumi flux : 110 Lm/W.

Power and Size :

18 Watt - 12 x 4.5 cm

24Watt - 17 x 4.5 cm

30 Watt - 17 x 4.5 cm

36 Watt - 22 x 4.5 cm

40 Watt - 23 x 4.5 cm

50 Watt - 30 x 4.5 cm





Surface Mounted Downlight

Code : DS-BC553

Power : 7 - 14 Watt .

CCT : 4000K

CRI > 90.

Size : 100x100x8 cm.

200x100x8 cm.

Beam Angle : 100°.

Power Factor : 0.6 .

Luminous flux : 110 Lm/W.

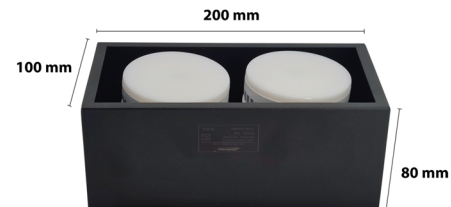
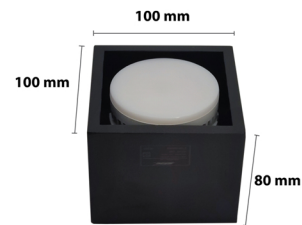

Surface Mounted Downlight

Code : DS-BC554

Power : 7 - 14 Watt .

CCT : 4000K

CRI > 90.

Size : 115x115x5.5 cm.

225x115x5.5 cm.

Beam Angle : 100°.

Power Factor : 0.6 .

Luminous flux : 110 Lm/W.

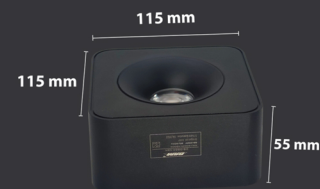

Surface Mounted Downlight

Code : DS-BC551-552

Power : 12 - 24 Watt .

CCT : 4000K – 6500K.

CRI > 95.

Size : 103x103x9.5 cm.

200x103x9.5 cm.

Beam Angle : 90°.

Power Factor : 0.6 .

Luminous flux : 110 Lm/W.

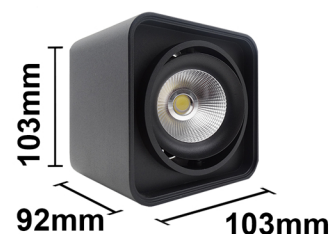
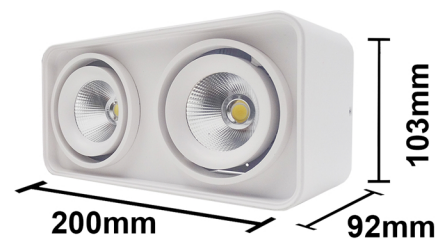

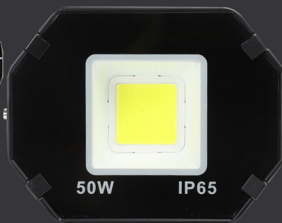
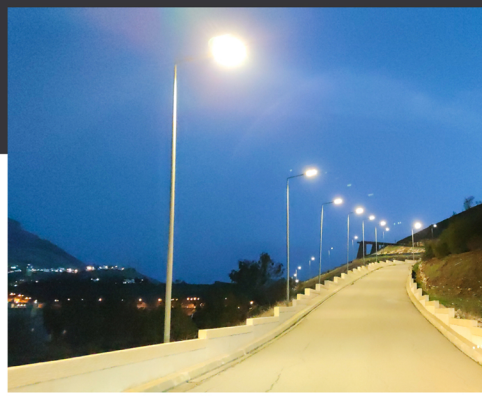

OUTDOOR LIGHTING

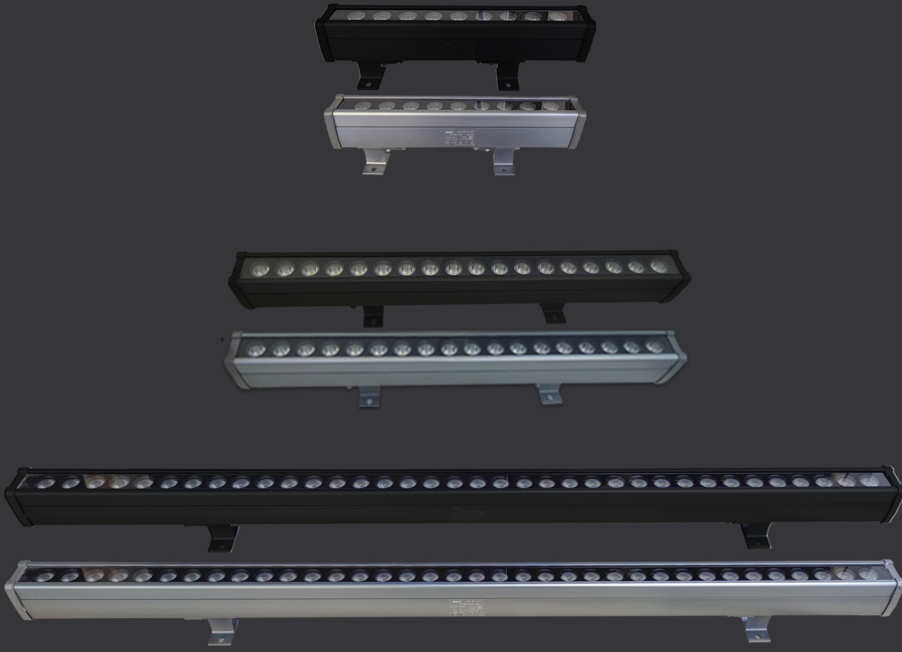

Two Side

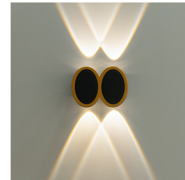
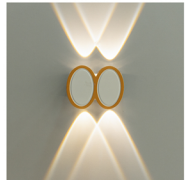
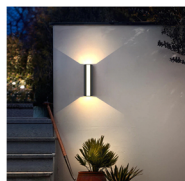
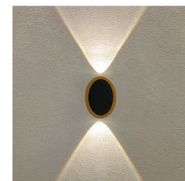
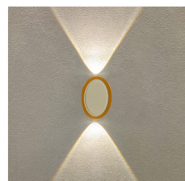
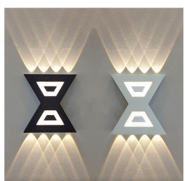

LED Garden light

DS-PL0017
70 Watt

DS-PL0019
120Watt

DS-PL0018
70 Watt

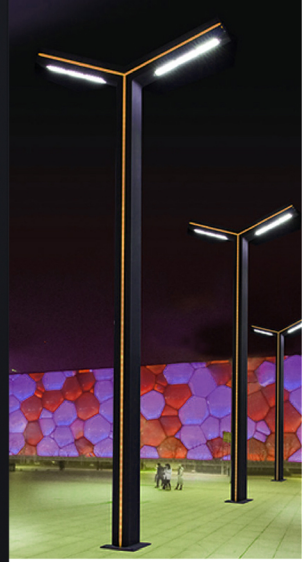

Product height : 3.5 m
 Color temp : 4000K - 4200K
 Strip color temp : Yellow
 LED chipa : PHILIPS / BRIGDELUX/OSRAM
 Lens angle : 120° - 70°
 Input Voltage : AC85-265V
 Protection Levels : IP65
 Material : 6063 Aluminum

Product effect:



Other Performance:

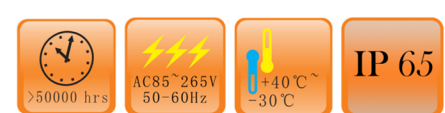



BAM Light Address

China Office /

NO 08, 14Th Floor, Dongxing Middle Road, Guzhen Town, Zhongshan City, Guangdong Province, China.

China Factory /

Floor 4, No. 5, Lifeng Road, Zone A, Maohui Industrial Zone, Henglan Town, Zhongshan City, Guangdong province, China.

Sulaymaniyah /

BAM Light, Talary Mammand , Opposite Edison Market 2 Electric, Kaneaskan Street, Sulaymaniyah, IRAQ

Sulaymaniyah /

BAM 2, Below Kobane Bridge, Opposite Alton Supermarket, Malik Mahmoud Circular Street, Sulaymaniyah, IRAQ.

Erbil /

Munwar Showroom, Opposite Setaqan Gasi , Erbil, IRAQ.

Erbil /

BAM Light, Waziran Street, Bakhtyari , Erbil, IRAQ.

Scan me



www.bamlight.com

info@bamlight.com

+964 750 152 20 72

+964 771 152 2072